

KEY FEATURES

- ❖ Fully supports Base/Medium/Full/Deca configurations for Camera Link™ cameras/frame grabbers
- ❖ Provides 850 Mbytes/s effective image data bandwidth
- ❖ Direct plug – no electrical camera link cable needed
- ❖ Minimum only 2 fibers are required with two simplex LC fiber connectors
- ❖ Support PoCL function for powering cameras
- ❖ Single 5V~24V DC power supply
- ❖ Included international AC/DC adapters accepting 100~240V AC power
- ❖ Transmission distance up to 300m with OM3 multimode fiber and up to 80km with single mode fiber.
- ❖ Compact size – 59L x 39.4W x 17H mm (2.326L x 1.551W x 0.669H inch)

TARGET APPLICATIONS

- ❖ Solar panel or glass panel inspection
- ❖ Semiconductor wafer inspection
- ❖ High speed printing inspection
- ❖ High precision surface inspection (e.g. airplane surface or automobile painting)
- ❖ Automated product inspection (e.g. food, drinking or pharmaceutical products)
- ❖ High resolution and real-time analysis for science, sports, automobile tests, and 3-D animation.
- ❖ High precision security surveillance (e.g. border control, airport)
- ❖ Traffic surveillance/control and vehicle license plate reading/recording (e.g. toll booth)
- ❖ Cameras placed in harsh environment (e.g. nuclear plant, steel mill or undersea monitoring)
- ❖ Other Machine Vision Applications

PHRONTIER™
TECHNOLOGIES

PHAST™ Camera Link Fiber Adapter

Base/Medium/ Full/Deca Configurations

PHF-FI-M300
PHF-FI-Sxx
PHF-FI-Bxx
PHF-FI-C10-BxxFxx

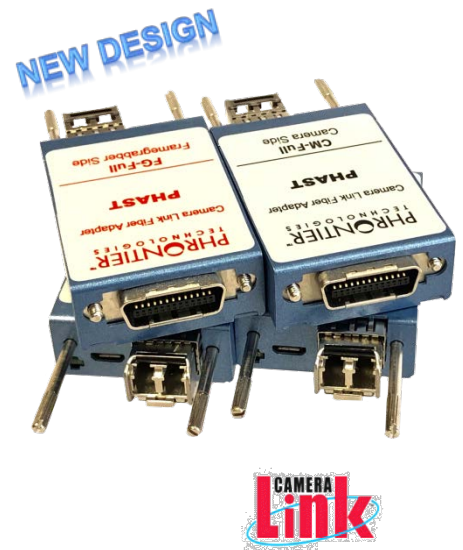

Phrontier Technologies, LLC

www.phrontier-tech.com

sales@phrontier-tech.com

Toll Free: 1-866-389-2829

TYPICAL SET UP DIAGRAM

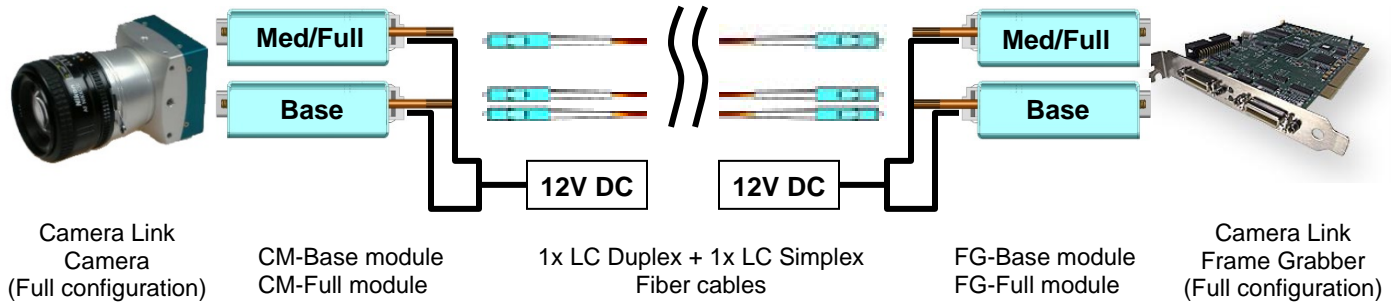

TECHNICAL SPECIFICATIONS

General Specification

Standard Operating Temperature	Ambient	0 ~ 50 °C	Case	0 ~ 60 °C
Extended Operating Temperature ¹	Ambient	-40 ~ 65 °C	Case	-40 ~ 75 °C
Storage Temperature	-40 ~ 85 °C			
Input Voltage	DC 5 ~ 24 V			
Typical Supply Current @12V DC ²	CM-base + CM-full	PHF-FI-M300	0.28 Amp	
		PHF-FI-S10	0.34 Amp	
	FG-base + FG-full	PHF-FI-M300	0.35 Amp	
		PHF-FI-S10	0.38 Amp	
Typical Power Consumption @12V DC ²	CM-base + CM-full	PHF-FI-M300	3.4W	
		PHF-FI-S10	4.1W	
	FG-base + FG-full	PHF-FI-M300	4.2W	
		PHF-FI-S10	4.6W	
Connector Type	Micro USB type B with custom pin assignment			
Approx. Weight per module	75 gram			

Note 1. For CWDM models, the extended ambient is only available for -20~55C due to the component limitation.

Note 2. Measured at room temperature.

Camera Link Interface

Pixel Clock Range	20 ~ 85MHz
Supported Camera Configuration	Base, Medium, Full, 10taps x 8bits, 8taps x 10bits

PHAST Series

Effective Data Throughput		850 Mbytes/s
Connector Type		MDR26 plug
Signal Latency	Image	2.5 μ s
	SerTFG	1 μ s
	CC1~4	0.32 μ s
	SerTC	0.26 μ s

Optical Interface

	PHF-FI-M300	PHF-FI-S10	PHF-FI-C10 ³	PHF-FI-B10
Operating Wavelength	850nm	1310nm	1270 ~ 1610 with 20nm spacing	1270/1330/ 1310 nm
Average Tx Output Power	-5 to -1 dBm	-8 to +0.5 dBm	-5 to 0 dBm	-8 to +0.5 dBm
Min. Optical Rx Input Power	-11.1 dBm	-14.4 dBm	-15 dBm	-14.4 dBm
Max Optical Rx Input Power	0 dBm	+0.5 dB	+0.5 dB	+0.5 dB
Total Fiber Counts	3	3	3	2
Connector Type	1x LC duplex + 1x LC simplex			2x LC simplex
Fiber Type	OM3	SM	SM	SM
Estimated Link Distance	300m	10km	Setup dependent	10km

Note 3. More power options are available. Please see ordering information.

MECHANICAL INFORMATION (mm [inch])

Module dimensions

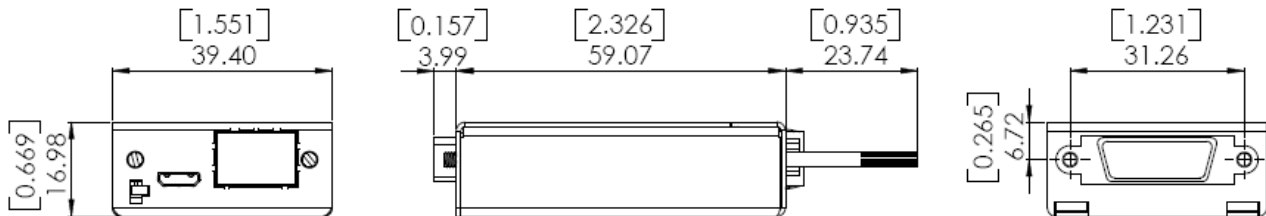

With Mounting Flange Options

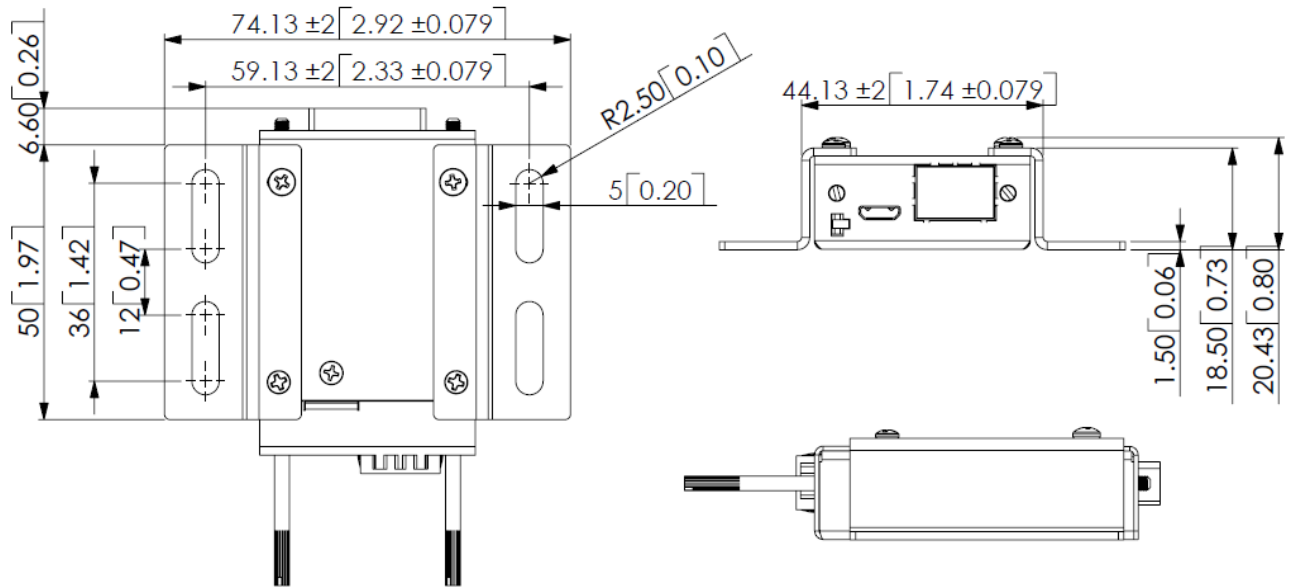

SDR plug to MDR receptacle adapter

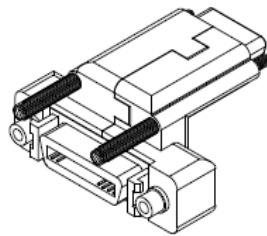
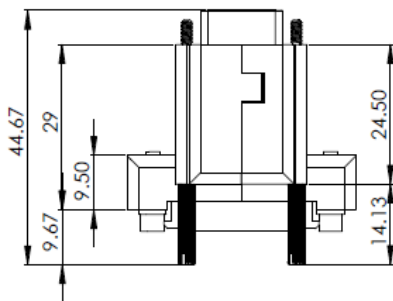

Down angle configuration

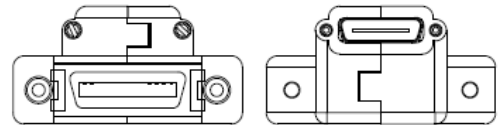

Up angle configuration

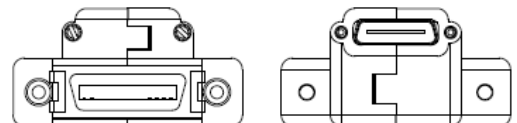
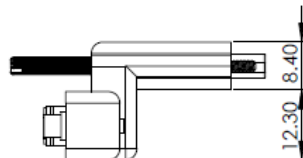
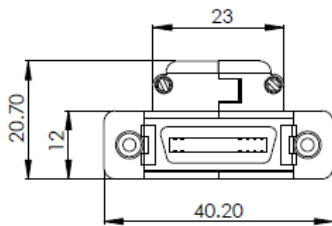

ORDERING INFORMATION

Standard Models

Model #	Estimated Link Distance	Fiber counts	Items Included
PHF-FI-M300	300m with OM3 fiber	3	1x CM-Base (for camera Base port) 1x CM-Full (for camera Full port)
PHF-FI-S10	10km	3	1x FG-Base (for grabber Base port) 1x FG-Full (for grabber Full port)
PHF-FI-B10	10km	2	2x 12V DC output international wall mount AC/DC power adapters with cable assembly (Fiber cables are not included)

Extended Temperature Models

Model #	Estimated Link Distance	Fiber counts	Items Included
PHF-FI-M300-T	300m with OM3 fiber	3	1x CM-Base (for camera Base port) 1x CM-Full (for camera Full port)
PHF-FI-S10-T	10km	3	1x FG-Base (for grabber Base port) 1x FG-Full (for grabber Full port)
PHF-FI-B10-T	10km	2	2x 12V DC output international wall mount AC/DC power adapters with cable assembly (Fiber cables are not included)

CWDM models

Each system requires different wavelengths. Users need to specify wavelengths for CMB, FGB and CMF modules. The FGF module will be receiver only and can be used for any wavelength. For example, using 1270, 1290 and 1310nm with 10dB power budget for a PHAST system will include PHF-FI-C10-CMB-27, PHF-FI-C10-FGB-29, PHF-FI-C10-CMF-31 and PHF-FI-C10-FGF.

Model #	Power Budget	Fiber counts	Optical Wavelengths	Items Provided
PHF-FI-C10-CMB-xx PHF-FI-C10-FGB-xx PHF-FI-C10-CMF-xx PHF-FI-C10-FGF	10dB	3	xx=27 for 1270 nm xx=29 for 1290 nm xx=31 for 1310 nm xx=33 for 1330 nm xx=35 for 1350 nm xx=37 for 1370 nm xx=39 for 1390 nm xx=41 for 1410 nm	1x CM-Base (for camera Base port) 1x CM-Full (for camera Full port) 1x FG-Base (for grabber Base port) 1x FG-Full (for grabber Full port) 2x 12V DC output international wall mount

<p>PHF-FI-C14-CMB-xx PHF-FI-C14-FGB-xx PHF-FI-C14-CMF-xx PHF-FI-C14-FGF</p>	14dB	<p>xx=43 for 1430 nm xx=45 for 1450 nm xx=47 for 1470 nm xx=49 for 1490 nm xx=51 for 1510 nm xx=53 for 1530 nm xx=55 for 1550 nm xx=57 for 1570 nm xx=59 for 1590 nm xx=61 for 1610 nm</p>	<p>AC/DC power adapters with cable assembly (Fiber cables are not included)</p>
--	------	---	---

Accessory

Part #	Description
618-MUSB-2	Y-split power cable with Switchcraft TA3MLX
MUSB-2	Y-split power cable with open wire pigtail
618-TRG10R-TA3FX	12V DC international wall mount AC/DC adapter with Switchcraft TA3FX
618-TRG10R-MUSB-2	618-TRG10R-TA3FX + 618-MUSB-2
LC-LC-S-D-xxxM	LC to LC duplex 9/125 μ m SM fiber. xx = desired length in meters.
LC-LC-M-D-xxxM	LC to LC duplex 50/125 μ m OM2 MM fiber. xx = desired length in meters.
LC-LC-G-D-xxxM	LC to LC duplex 50/125 μ m OM3 MM fiber. xx = desired length in meters.
PHIRE-W	1 pair of mounting flanges
SDR-MDR-D	SDR plug to MDR receptacle adapter – DOWN configuration
SDR-MDR-U	SDR plug to MDR receptacle adapter – UP configuration



www.phrontier-tech.com

sales@phrontier-tech.com

Toll Free: 1-866-389-2829